

CERAMIC PEBBLE FUEL EFFECT INSTALLER AND OWNER GUIDE

**THIS GUIDE IS FOR FITTING THE 13 PEBBLE
CERAMIC FUEL EFFECT TO THE
939 MODEL FITTED WITH A
Basket Casting
ONLY.**

IMPORTANT

**THIS GUIDE MUST BE PLACED INSIDE OR ATTACHED
TO THE INSTALLER AND OWNER GUIDE SUPPLIED
WITH THE GAS FIRE. IT MUST BE LEFT WITH THE
OWNER.**

**THIS GUIDE MUST BE READ IN CONJUNCTION WITH
THE INSTALLER AND OWNER GUIDE SUPPLIED WITH
THE GAS FIRE.**

INSTALLER AND OWNER GUIDE

© Baxi Heating U.K. Limited 2006.

All rights reserved. No part of this publication may be reproduced in any material form (including photocopying), stored in any medium by electronic means (including in any retrieval system or database) or transmitted, in any form or by any means, whether electronic, mechanical, recording or otherwise, without the prior written permission of the copyright owner.

Applications for the copyright owner's permission to reproduce any part of this publication should be made, giving details of the proposed use, to the following address:
The Company Secretary, Baxi Heating UK Limited, Pentagon House, Sir Frank Whittle Road, Derby, DE21 4XA.

Warning: Any person who does any unauthorised act in relation to a copyright work may be liable to criminal prosecution and civil claims for damages.

Baxi Fires Division, Erdington, Birmingham B24 9QP

Because our policy is one of constant development and improvement, details may vary slightly from those given in this publication

INSTALLER AND OWNER GUIDE

SAFETY

This product uses fuel effect pieces and burner compartment walls containing Refractory Ceramic Fibres (RCF), which are man-made vitreous silicate fibres. Excessive exposure to these materials may cause irritation to eyes, skin and respiratory tract. Consequently, it is important to take care when handling these articles to ensure that the release of dust is kept to a minimum. To ensure that the release of fibres from these RCF articles is kept to a minimum, during installation and servicing we recommend that you use a HEPA filtered vacuum to remove any dust and soot accumulated in and around the fire before and after working on the fire. When replacing these articles we recommend that the replaced items are not broken up, but are sealed within a heavy duty polythene bag, clearly labelled as RCF waste. RCF waste is classed as a stable, non-reactive hazardous waste and may be disposed at a landfill licenced to accept such waste. Protective clothing is not required when handling these articles, but we recommend you follow the normal hygiene rules of not smoking, eating or drinking in the work area and always wash your hands before eating or drinking.

This appliance does not contain any component manufactured from asbestos or asbestos related products.

FITTING THE CERAMIC PEBBLE FUEL EFFECT

The ceramic fuel effect may cause staining / discolouration to decorative surfaces. It is therefore advisable to protect decorative surfaces.

Note: Depending upon model the detail around the ceramic fuel effect may be different to that shown.

1. Place the ceramic base pebble in the burner compartment. The bottom rear face of the pebble should rest on the angled ledges at the back of the burner compartment. The bottom front recess edges on the pebble base should locate against the tags at the front of the ceramic support (See figure 1).

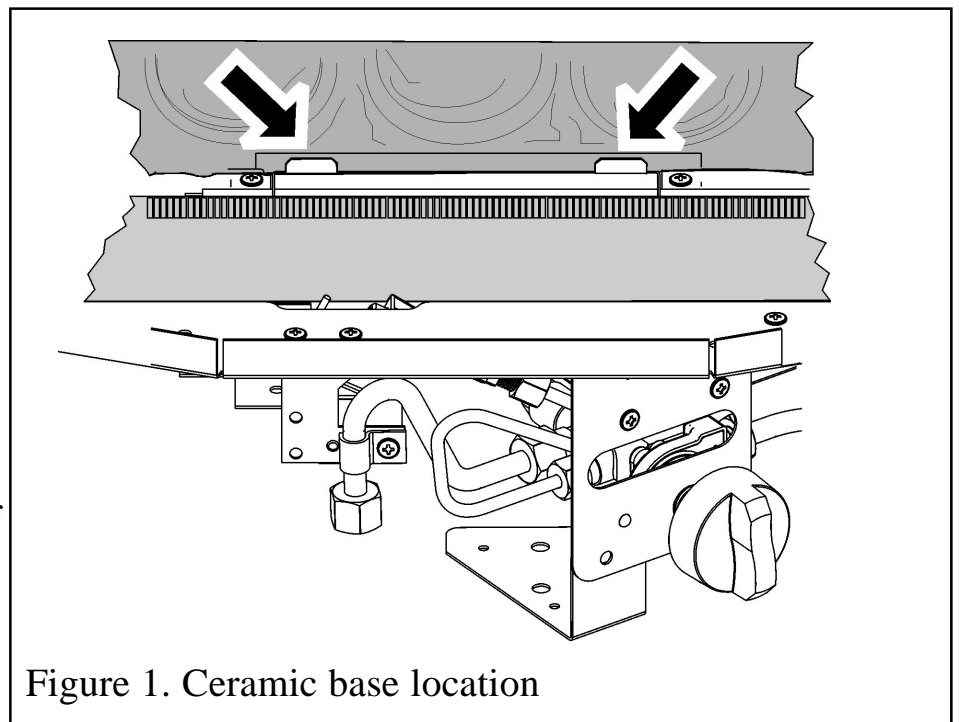
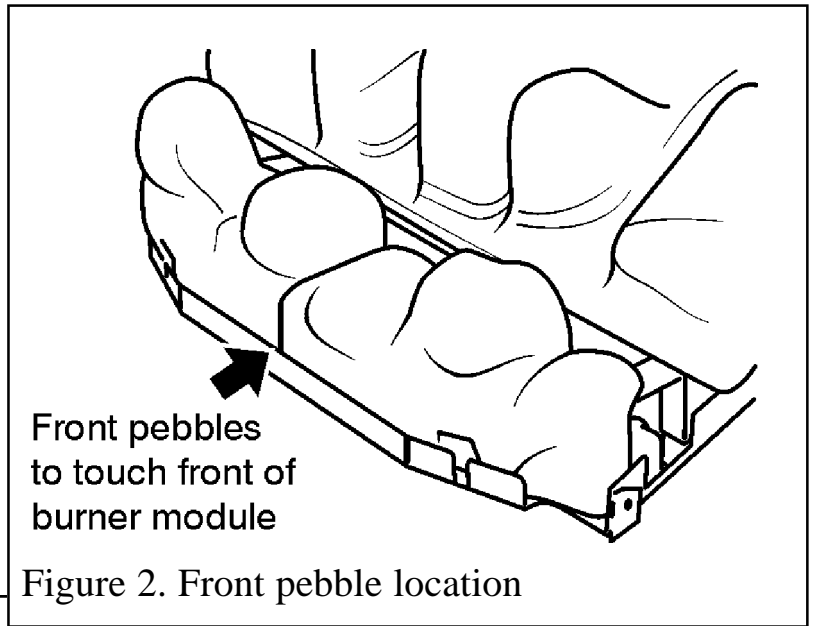

Figure 1. Ceramic base location

INSTALLER AND OWNER GUIDE

2. Place the right-hand ceramic front pebble in position in front of the base pebble. The front of the ceramic pebble should touch the front of the burner module (See figure 2).



3. Place the left hand ceramic front pebble in position in front of the base pebble. This should overlap the right-hand pebble. Push the two sides together to minimise the gap. The front of the ceramic pebble should touch the front of the burner module (See figure 2).

4. It is important that the front ceramics are positioned correctly and do not cover the burner ports in any way (See figure 2).

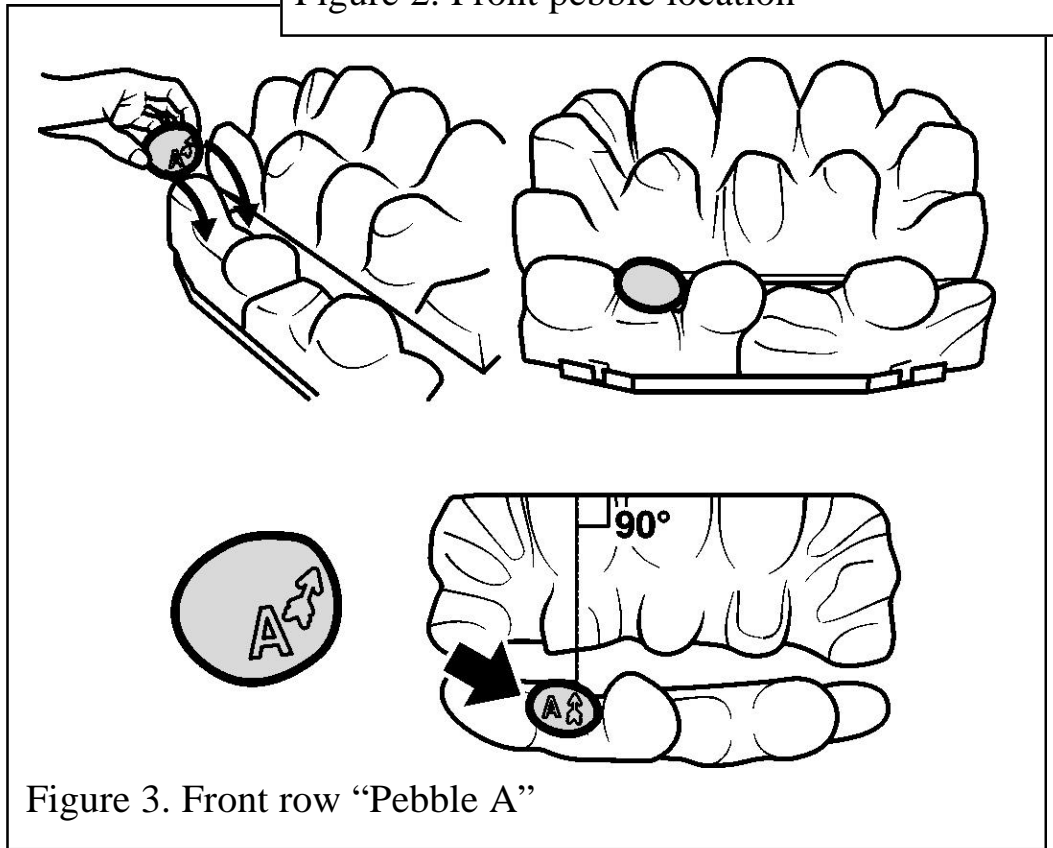

Install the 13 loose pebbles as follows. The underside of each pebble is marked with a letter 'A' to 'M' and an arrow.

The pebbles should be positioned so that the arrows always point towards the back of the firebox. When located into position the stem of each arrow should be at 90° to the rear of the firebox.

5. Hold pebble 'A' upright with the arrow pointing to the top. Locate pebble 'A' as shown in figure 3.

INSTALLER AND OWNER GUIDE

Locate pebbles 'B' to 'G' so that they are firmly seated in the valleys in the pebble base and front pebble.

6. Hold pebble 'B' upright with the arrow pointing to the top. Locate pebble 'B' as shown in figure 4.

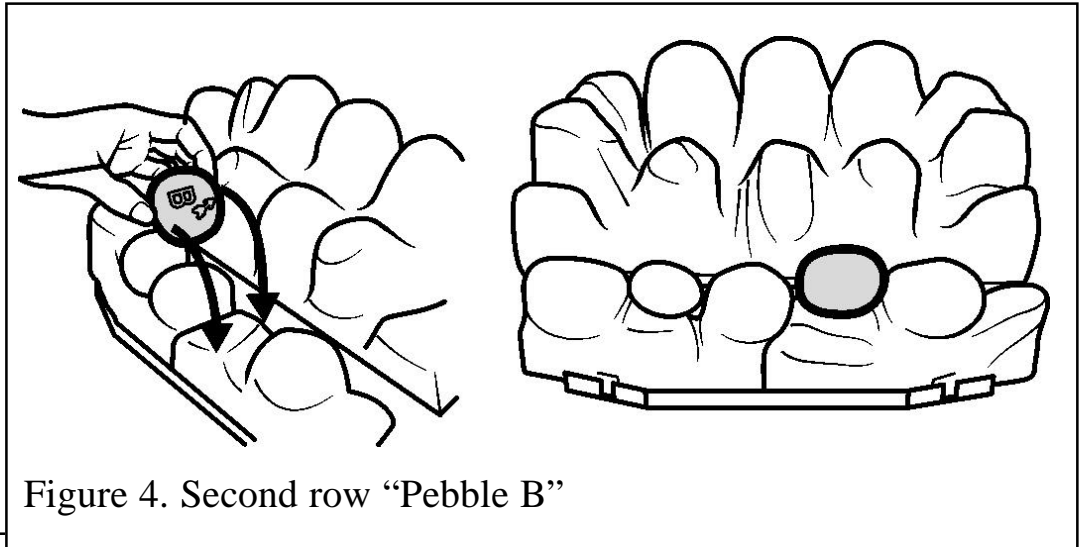

Figure 4. Second row "Pebble B"

7. Hold pebble 'C' upright with the arrow pointing to the top. Locate pebble 'C' as shown in figure 5.

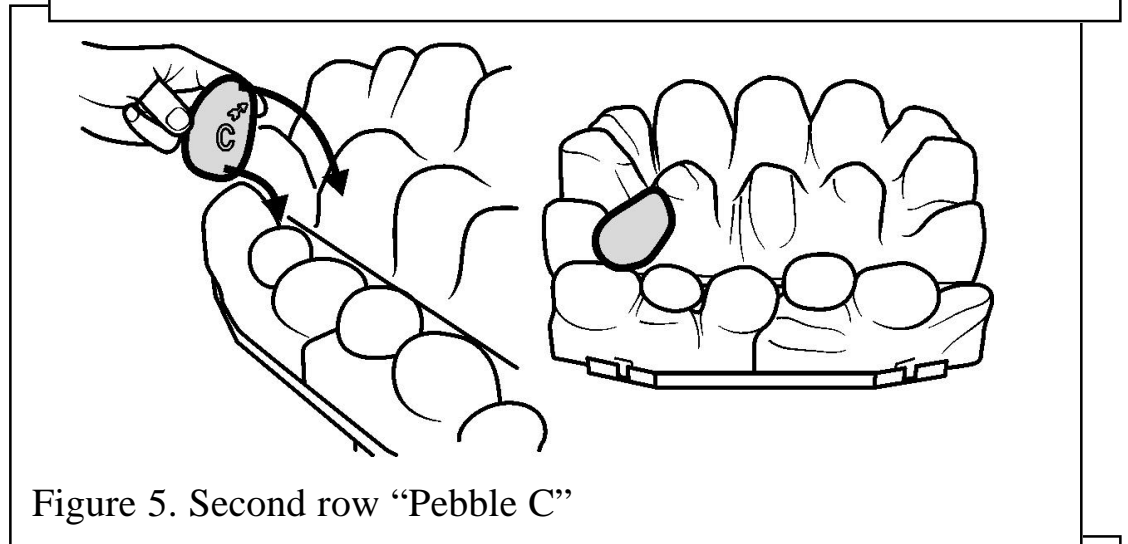

Figure 5. Second row "Pebble C"

8. Hold pebble 'D' upright with the arrow pointing to the top. Locate pebble 'D' as shown in figure 6.

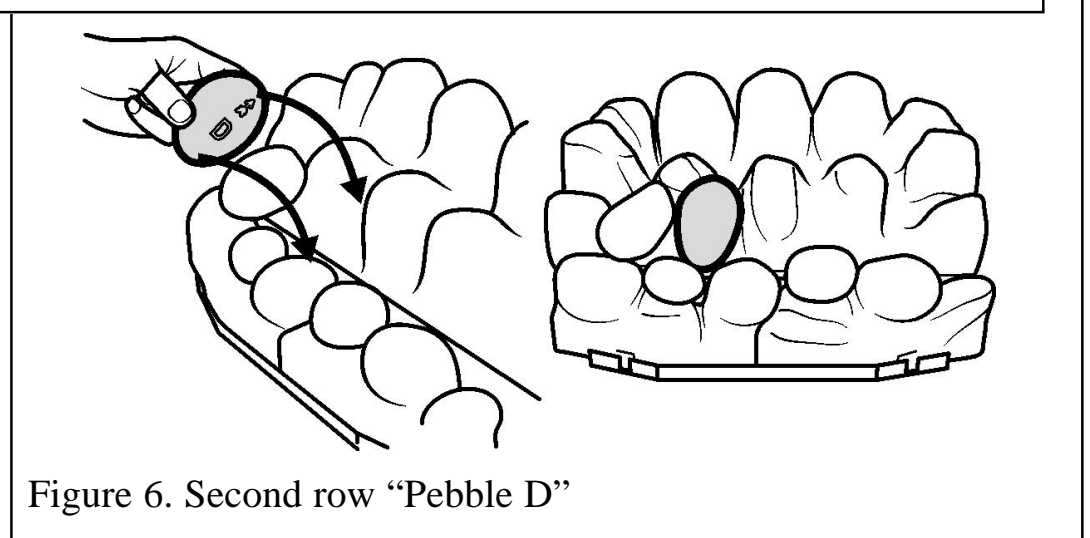

Figure 6. Second row "Pebble D"

INSTALLER AND OWNER GUIDE

9. Hold pebble 'E' upright with the arrow pointing to the top. Locate pebble 'E' as shown in figure 7.

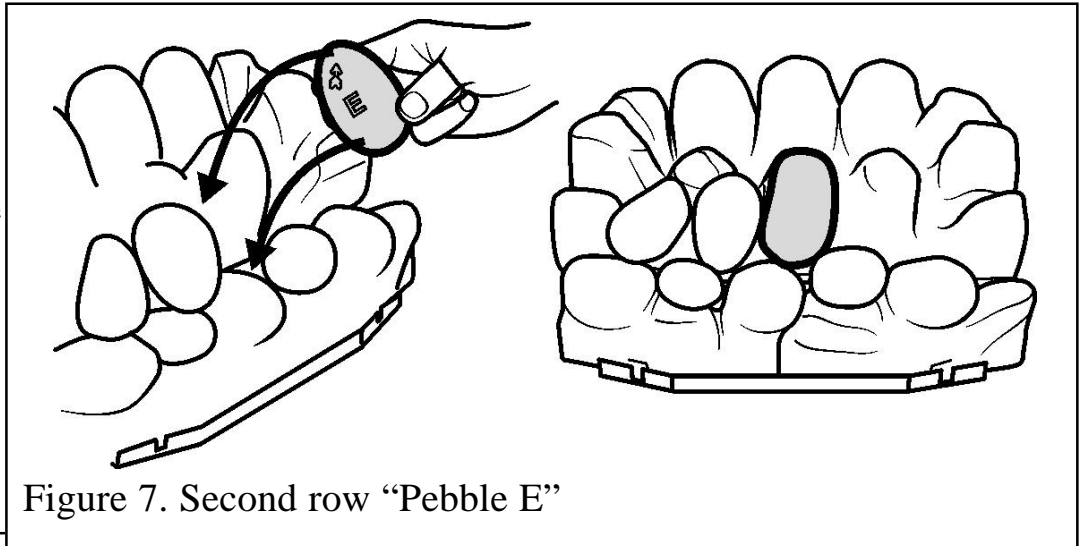

Figure 7. Second row "Pebble E"

10. Hold pebble 'F' upright with the arrow pointing to the top. Locate pebble 'F' as shown in figure 8.

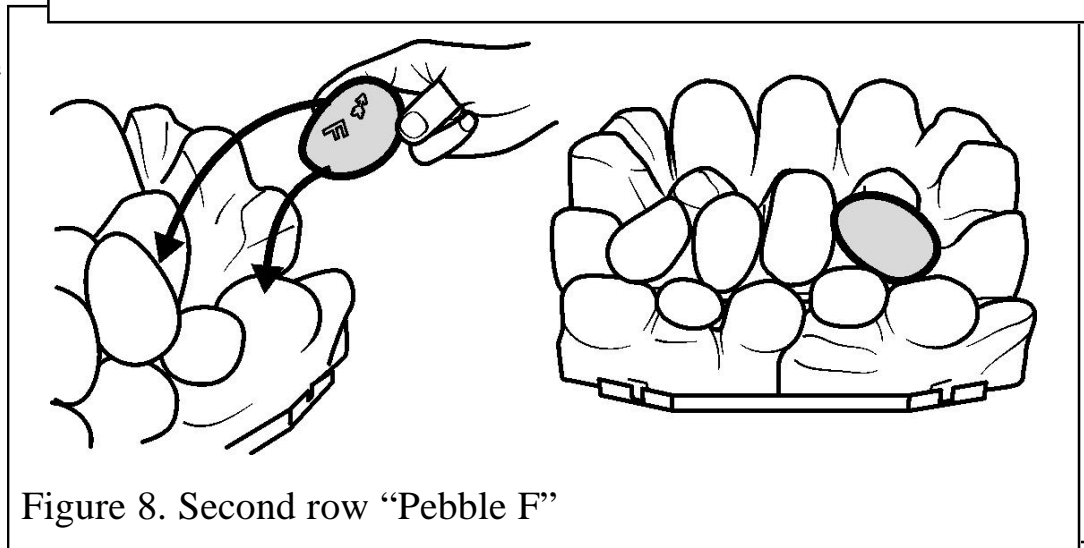

Figure 8. Second row "Pebble F"

11. Hold pebble 'G' upright with the arrow pointing to the top. Locate pebble 'G' as shown in figure 9.

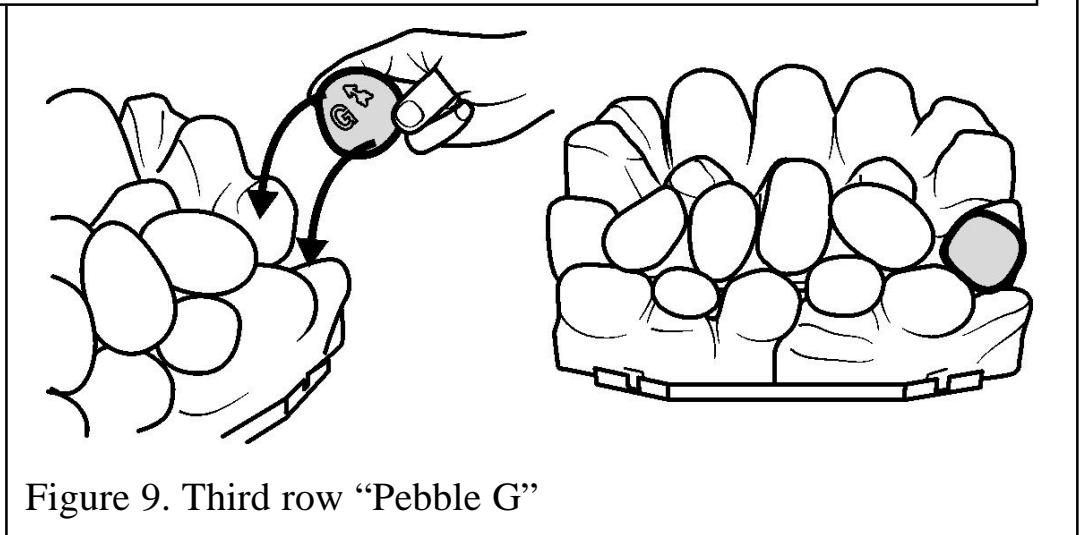

Figure 9. Third row "Pebble G"

This will complete the second row of loose pebbles. Locate pebbles 'H' to 'M' so that they are firmly seated in the valleys in the pebble base.

INSTALLER AND OWNER GUIDE

12. Hold pebble 'H' upright with the arrow pointing to the top. Locate pebble 'H' as shown in figure 10.

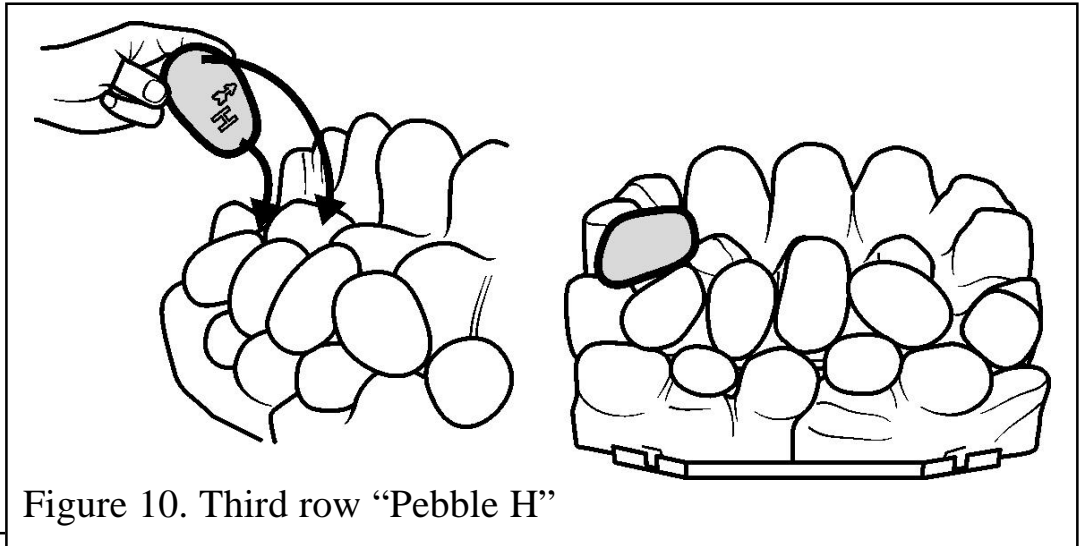

Figure 10. Third row "Pebble H"

13. Hold pebble 'I' upright with the arrow pointing to the top. Locate pebble 'I' as shown in figure 11.

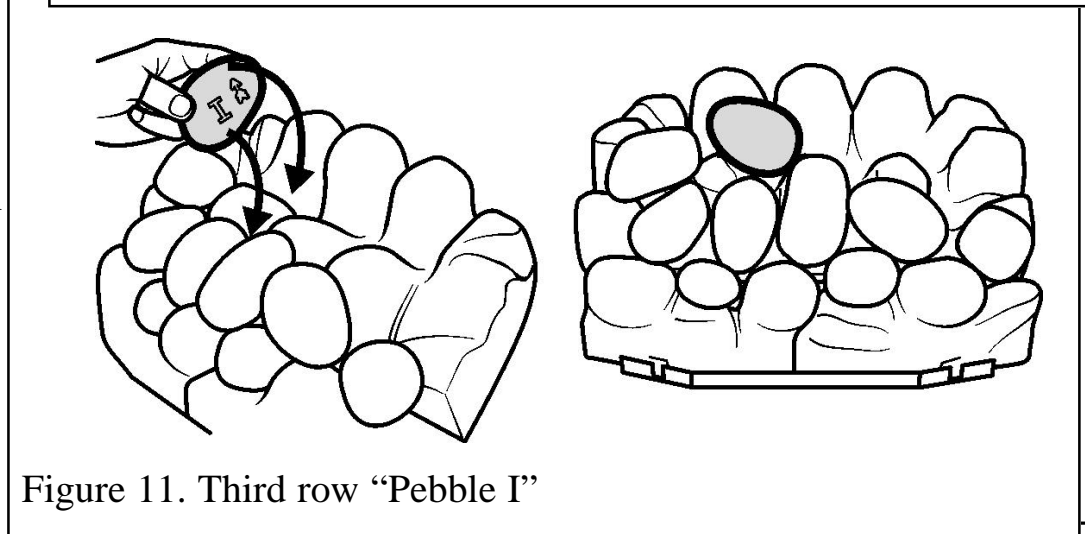

Figure 11. Third row "Pebble I"

14. Hold pebble 'J' upright with the arrow pointing to the top. Locate pebble 'J' as shown in figure 12

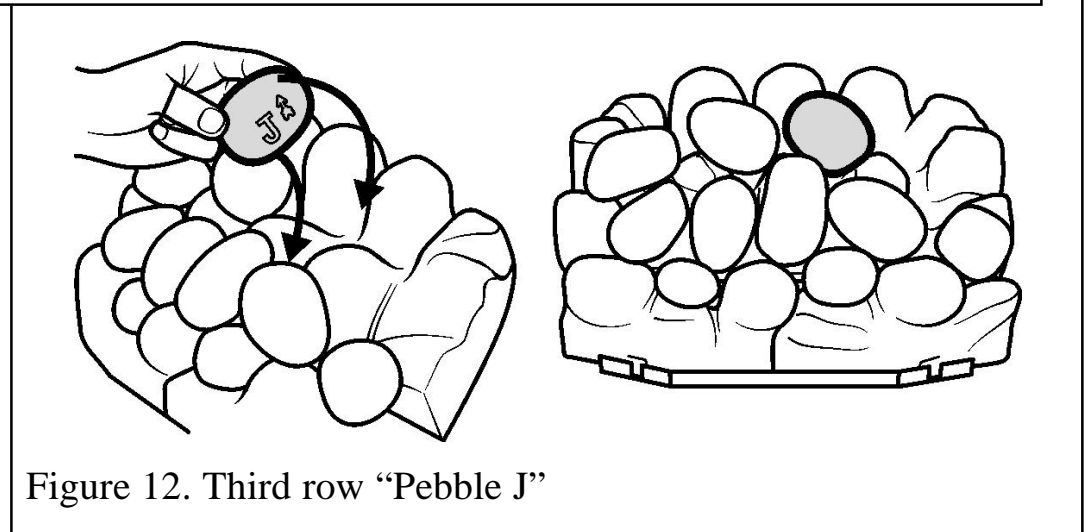

Figure 12. Third row "Pebble J"

INSTALLER AND OWNER GUIDE

15. Hold pebble 'K' upright with the arrow pointing to the top. Locate pebble 'K' as shown in figure 13.

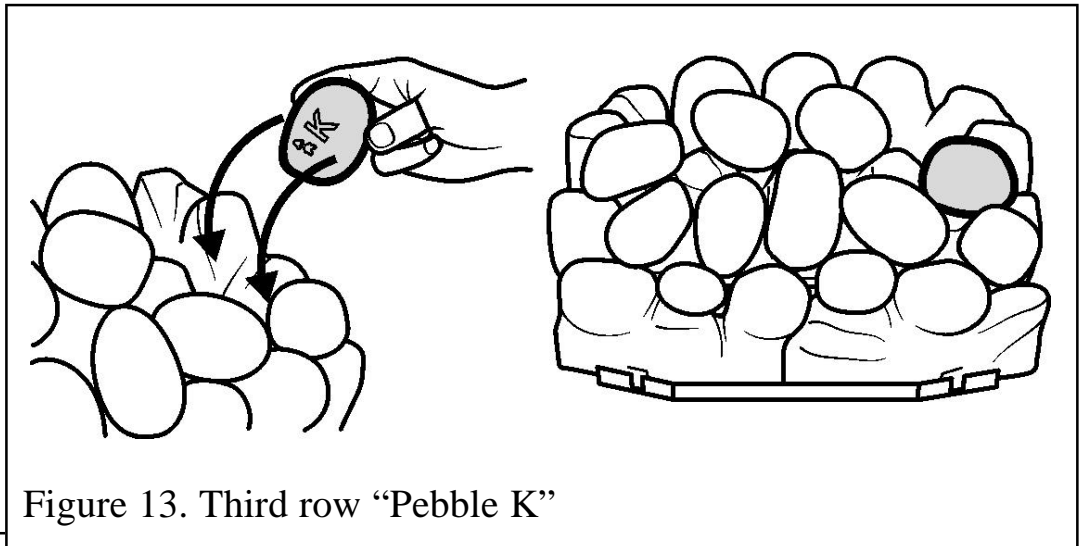

Figure 13. Third row "Pebble K"

16. Hold pebble 'L' upright with the arrow pointing to the top. Locate pebble 'L' as shown in figure 14.

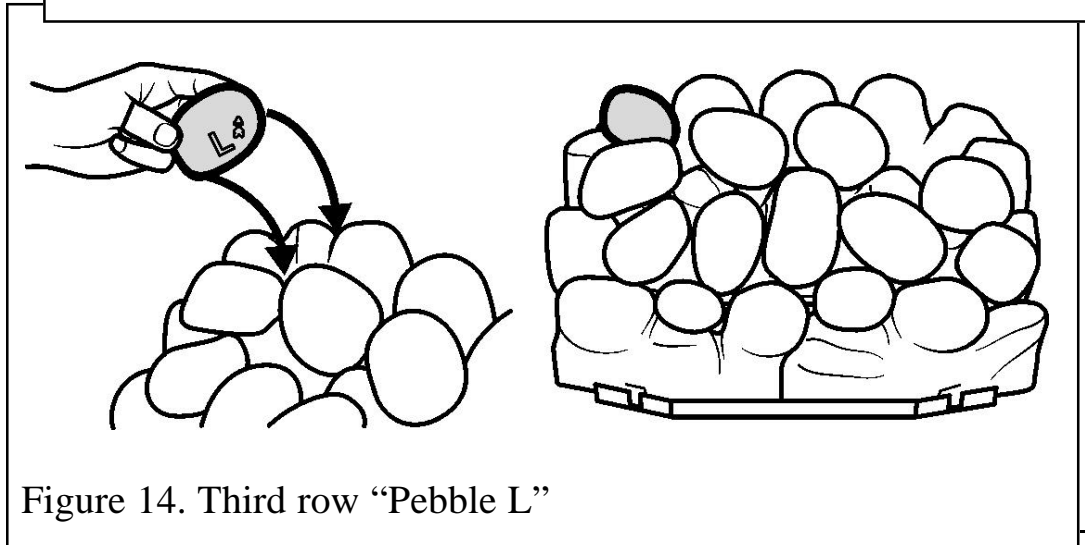

Figure 14. Third row "Pebble L"

17. Hold pebble 'M' upright with the arrow pointing to the top. Locate pebble 'M' as shown in figure 15.

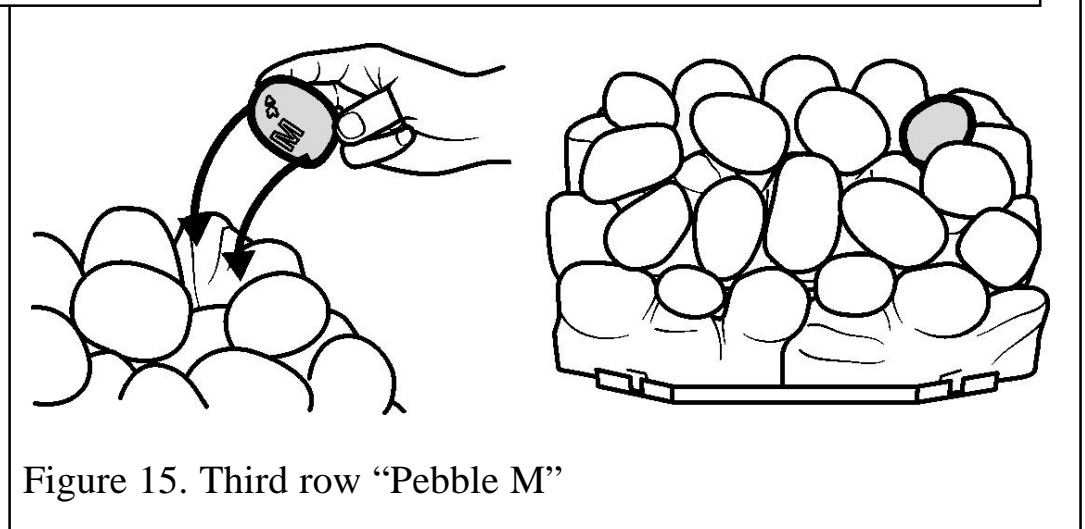

Figure 15. Third row "Pebble M"